

## **A study of Maximum Power Point Tracking Algorithm for Photovoltaic systems using a Fuzzy Logic controller**

Imad Elzein, Minsk

Belarusian National Technical University, imad.zein@liu.edu.lb

### **Abstract**

Solar panels have a nonlinear voltage-current characteristic, with a distinct maximum power point (MPP), which depends on the environmental factors, such as temperature and irradiation. In order to continuously harvest maximum power from the solar panels, they have to operate at their MPP despite the inevitable changes in the environment. This is why the controllers of all solar power electronic converters employ some method for maximum power point tracking (MPPT). Over the past years many MPPT techniques have been published and based on that the main paper's objective is to analyze one of the most promising MPPT control algorithms: fuzzy logic controller.

### **I. Introduction**

According to the realization of high efficiency and low cost photovoltaic (PV) modules, interest in photovoltaic power generation system has increased over the past decade as a clean and infinite energy [1]. The PV modules have maximum operating points corresponding to the surrounding condition such as intensity of the sunlight, the temperature of the PV modules, cell area, and load. When solar energy is used as a power source, the output power has to be maximized by improving the efficiency of the power conditioning equipment used and implementing an adaptive power controller that automatically tracks the system to the point of maximum power delivered from the solar panel under all conditions.

Solar energy has offered promising results in the quest of finding the solution to the problem. The harnessing of solar energy using PV modules comes with its own problems that arise from the change in insulation conditions. These changes in insulation conditions severely affect the efficiency and output power of the PV modules. A great deal of research has been done to improve the efficiency of the PV modules. A number of methods of how to track the maximum power point of a PV module have been proposed to solve the problem of efficiency and products using these methods have been manufactured and are now commercially available for consumers [1].

Maximum Power Point Tracking (MPPT) is the newest concept which helps to extract the maximum possible power from a PV array. The MPPT methods are various in the complexity, convergence speed, popularity, cost, operating range, sensor dependence, capability of escaping from local optima and their applications [2]-[7].

One of the most significant issues in PV system and MPPT efficiency is DC-DC converter. In recent years, there has been increasing interest in the development of efficient control strategies to improve dynamic behavior of DC-DC converters by using traditional PID based controllers

and fuzzy logic controller (FLC), neural networks (NN), and neuro-fuzzy controller or adaptive fuzzy logic controller (AFLC) which have been used to control buck, boost and buck–boost converter which were presented.

The authors [8-14] have designed a different control model and implementation has been made to regulate DC–DC converter by using a digital signal processor (DSP TMS320C50).

Different control technologies were used to control DC–DC converter using a microcontroller and an extra specialized hardware proposed a FLC that uses an optimal algorithm, and they have given experimental results.

Design of fuzzy logic has been applied to a broad variety of engineering problems, particularly those having nonlinear dynamics [15]-[20]. Fuzzy logic controllers have been implemented as embedded controllers for frequency controlled induction motor drives. Numerous electric motor drive problems have been solved using fuzzy principles [21]-[23]. Studies have also recommended utilizing FLC in situations where (1) there is no precise mathematical model for the plant and (2) there are experienced human operators who can satisfactorily control the plant and provide qualitative control rules in terms of vague and fuzzy sentences.

There are many practical situations where both (1) and (2) are true.

Furthermore, corresponding authors made their effort in the design of Fuzzy Logic Controllers and demonstrated some difficulties in the selection of optimized membership functions and fuzzy rule base, which is traditionally achieved by a tedious trial-and-error process.

This paper is a synthesis of works by [ 10,15,16,21,22 ] and introduces a systematic approach to construct FLC for DC–DC converters as a part of Maximum Power Point Tracing system of Photovoltaic station to adapt to photovoltaic modules under varying operating conditions and the nonlinear properties of DC-DC power converters.

The modified FLC (MFLC) optimizes membership functions and rule base of the FLC were obtained from training data in the pattern file.

An MFLC approach is general in the sense that it is almost the same control rules can be applied to other applications [21].

### 1.1 PV Arrays

A solar panel cell basically is a p-n semiconductor junction. When exposed to the light, a DC current is generated. The generated current varies linearly with the solar irradiance [3]. The equivalent electrical circuit of an ideal solar cell can be treated as a current source parallel with a diode shown in figure 1.

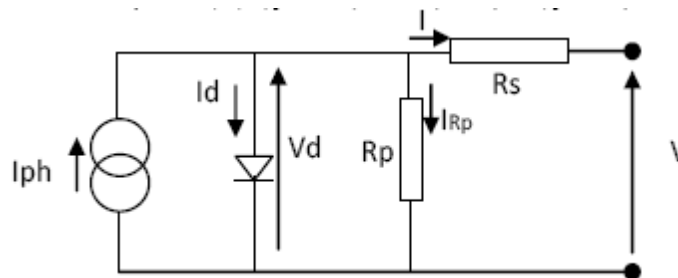

Fig. 1: Equivalent electrical circuit of a solar cell

The I-V characteristics of the equivalent solar cell circuit can be determined by following equations [3]. The current through diode is given by:

$$I_D = I_O [ \exp (q(V + I R_S)/KT) - 1 ] \quad (1)$$

While, the solar cell output current:

$$I = I_L - I_D - I_{sh} \quad (2)$$

$$I = I_L - I_O [ \exp (q(V + I R_S)/KT) - 1 ] - ( V + I R_S ) / R_{sh} \quad (3)$$

Where:

$I$ : Solar cell current (A)

$I_L$ : Light generated current (A) [Short circuit value assuming no series/ shunt resistance]

$I_O$ : Diode saturation current (A)

$q$ : Electron charge ( $1.6 \times 10^{-19}$  C)

$K$ : Boltzman constant ( $1.38 \times 10^{-23}$  J/K)

$T$ : Cell temperature in Kelvin (K)

$V$ : solar cell output voltage (V)

$R_S$ : Solar cell series resistance ( $\Omega$ )

$R_{sh}$  or  $R_p$ : Solar cell shunt resistance ( $\Omega$ )

## 2. Maximum Power Point Tracking (MPPT)

The power output from PV array depends significantly on the array characteristics and the loading conditions, a typical I-V and P-V characteristic is shown in Figures 2 and 3 respectively.

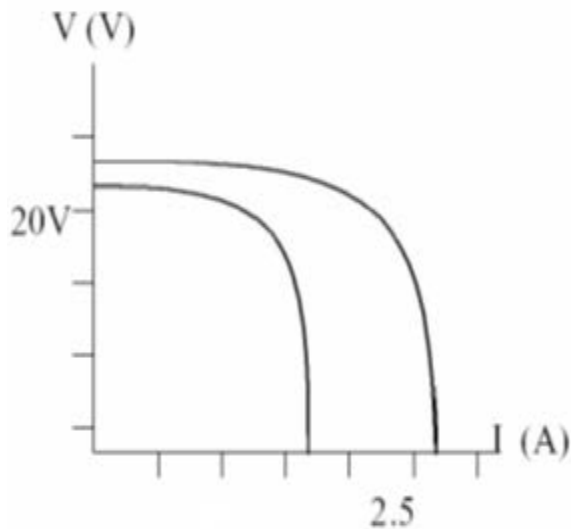

Fig.2 ideal V-I characteristics of a PV array

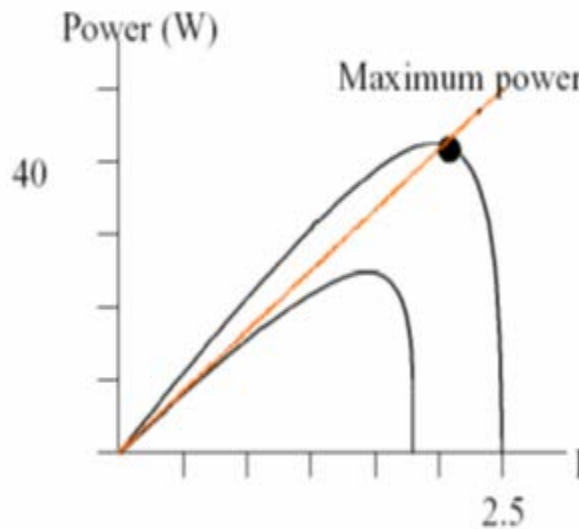

Fig.3 ideal P-I characteristics of a PV

What maximum power point tracking does is locating the current operation point and finding the direction of change for maximizing the power. The maximum power point is not a fixed point. As the MPP changes the power delivered to the load is reduced. The MPPT is required to match the load to the PV array irrespective of the variations in the MPP or in the load itself. The maximum power is transferred only under the matched conditions.

However, the location of the MPP in the I–V plane is not known a priori. It must be located, either through model calculations or by a search algorithm. The situation is further complicated by the fact that the MPP depends in a nonlinear way on irradiance and temperature, as illustrated in Figure 4. Figure 4(a) shows a family of PV I–V curves under increasing irradiance, but at constant temperature, and Figure 4(b) shows I–V curves at the same irradiance values, but at a higher temperature. Note the change in the array voltage at which the MPP occurs. [4]

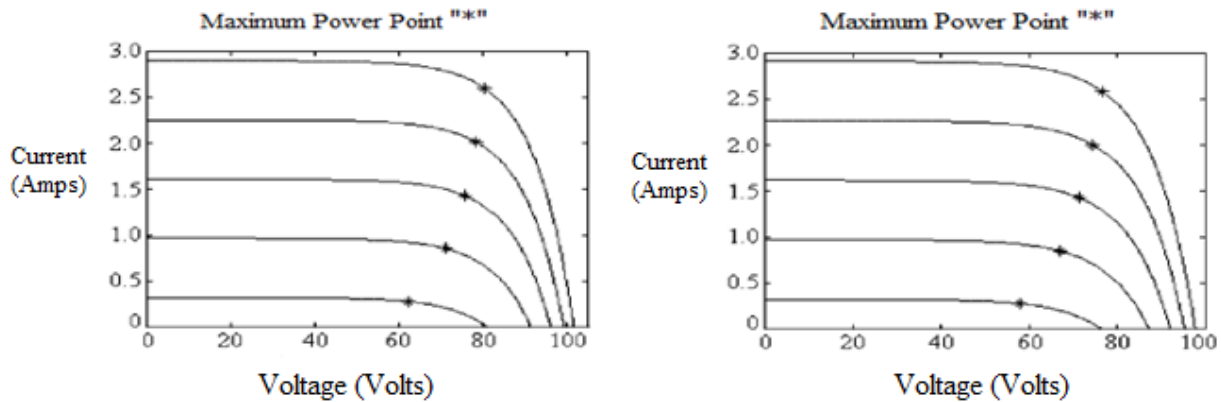

Figure 4. (a) PV array voltage-current at 40°C at different irradiance levels (b) PV array voltage–current at 50°C at different irradiance level

MPPT algorithm is designed in order for the photovoltaic station to adapt to environmental changes in a way that the optimal power is extracted. As it can be seen from Fig.4 to reach MPPT point it is necessary to change voltage or current.

As usual MPPT algorithms integrated into electronic converter system to control the duty cycle of the DC-DC converter which leads to deliver maximum available power from solar array. There is a certain diversity of MMPT algorithms have been reported in the base of this the literature [3,4,7]. The most common base of this algorithms is the perturb and observe (P&O) method [6,7,8]. While P&O method is relatively simple it causes the system to oscillate around the maximum power point even in the steady state condition of the solar array irradiance.

As it was mentioned before the core of any MPPT algorithm is DC-DC controller which is a subject of our study.

### 3. Fuzzy logic controller

In recent years, there has been increasing interest in the development of efficient control strategies to improve dynamic behavior of DC–DC converters by using fuzzy logic controller (FLC), neural networks (NN), and neuro-fuzzy controller or adaptive fuzzy logic controller (AFLC) - have been used to control buck, boost and buck–boost converter were presented.

The authors [10,11,17] have designed a different control model and implementation has been made to regulate DC–DC converter by using a digital signal processor (DSP TMS320C50).

Different control technologies were used to control DC–DC converter using a microcontroller and extra specialized hardware have proposed an FLC that uses an optimal algorithm, and they have given experimental results.

Design of fuzzy logic has been applied to a broad variety of engineering problems, particularly those having nonlinear dynamics. Fuzzy logic controllers have been implemented as embedded controllers for frequency controlled induction motor drives. Numerous electric motor drive problems have been solved using fuzzy principles [ 22,23,24 ]. Researches have also proposed to

Use the FLC in situations where it could be useful in (1) there is no precise mathematical model for the plant and (2) there are experienced human operators who can satisfactorily control the plant and provide qualitative control rules in terms of vague and fuzzy sentences.

The use of fuzzy logic control has become popular over the last decade because it can deal with imprecise inputs, does not need an accurate mathematical model and can handle nonlinearity. Microcontrollers have also helped in the popularization of fuzzy logic control. [5]

The implementation of fuzzy logic is used to have a faster controller response and to increase system stability once reached the MPP. The tracking of the MPP will be divided into two phases: the first phase is of tough research, with a significant step to improve the response of the MPPT controller, the second one is the fine phase where the step is very small, thus ensuring the system stability and decrease the maximum oscillations around the MPP. This feature of the fuzzy controller demonstrates its effectiveness and makes it among the best MPP tracking devices.

The fuzzy controller consists of three blocks: the Fuzzification of input variables which is performed in the first block, it allows the passage from the real domain to fuzzy domain. The second block is devoted to inference rules, while the last block is the Defuzzification for returning to the real domain. This last operation uses the center of mass to determine the value of the output [16].

The FLC block diagram to control DC-DC power converter in MPPT system of PVS is presented in Fig.5.

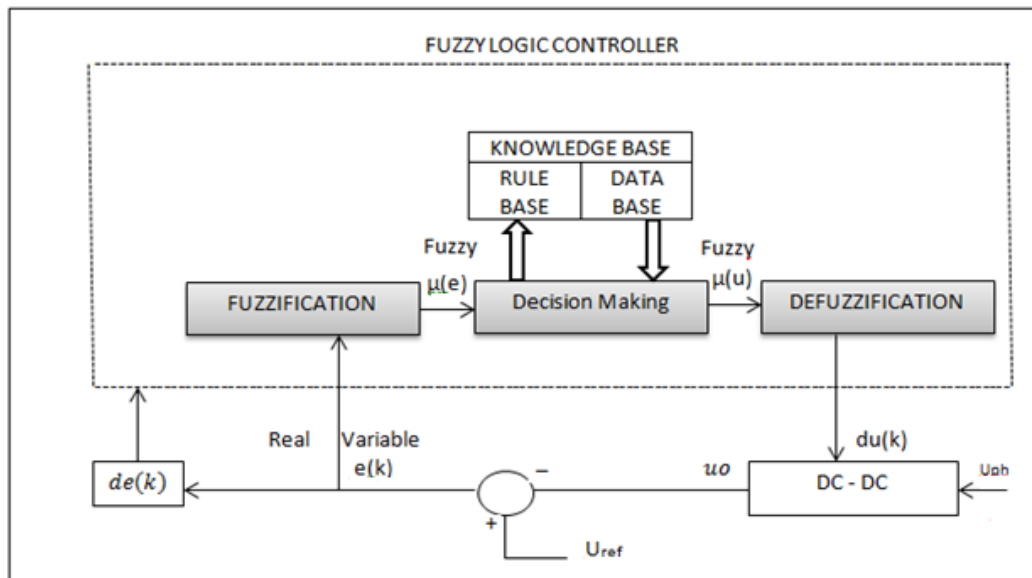

Fig.5 The basic structure of the Fuzzy Logic Controller

Corresponding authors made their effort in design of Fuzzy Logic Controllers and demonstrated some difficulties in the selection of optimized membership functions and fuzzy rule base, which is traditionally achieved by a tedious trial-and-error process.

The modified FLC (MFLC) optimizes membership functions and rule base of the FLC were obtained from training data in the pattern file.

The inputs of Fig.5 of the FLC are the error  $e$  and difference of error  $de$  respectively and they are defined as

$$e = U_{ref} - U_0 \quad (4)$$

$$de(k) = e(k) - e(k-1) \quad (5)$$

Where  $U_{ref}$  is reference output voltage,  $U_0$  is actual output voltage of DC–DC converter at the  $k$ th sampling time.

The output of the FLC is a change in duty ratio ( $du(k)$ ).

Duty ratio  $d(k)$ , at the  $k$ th sampling time, is defined as:

$$d(k) = d(k-1) + du(k) \quad (6)$$

Knowing that, the output of the controller then sends through PWM out to DC-DC converter to generate desired switching action (Fig.5).

Shrinking-span membership functions algorithm is used to construct membership functions for FLC. Then the result of (5) is send through the PWM controller to DC–DC converter to generate desired switching action. By using this method the designer of an FLC assigns only the number of elements of term set and shrinking factor.

In fact, the shrinking-span membership functions [16] (SSMF) is constructing membership functions method for FLC which, in compare to [21], generates a series of orderly arranged membership functions  $A(x_i)s$  in the FLC for a linguistic variable across its universe of discourse. For example [16], widely used trapezoidal family SSMF is showing on Fig.6 for the membership number of linguistic variables  $m=3$ , shrinking factors  $s=0.65$  and overlapping  $b=1$ . In case when shrinking factor is chosen one, the membership functions have equal span .Using various shrinking factors to the same linguistic variable, different membership function obtained to examine which is the most suitable for a specific application process.

The overlapping factor has range  $[0,1]$  and increases monotonously as  $b$  increases.

It is clear that there is no overlap between SSMF and if  $b=1$  the supports for the SSMF have proper overlapping region.

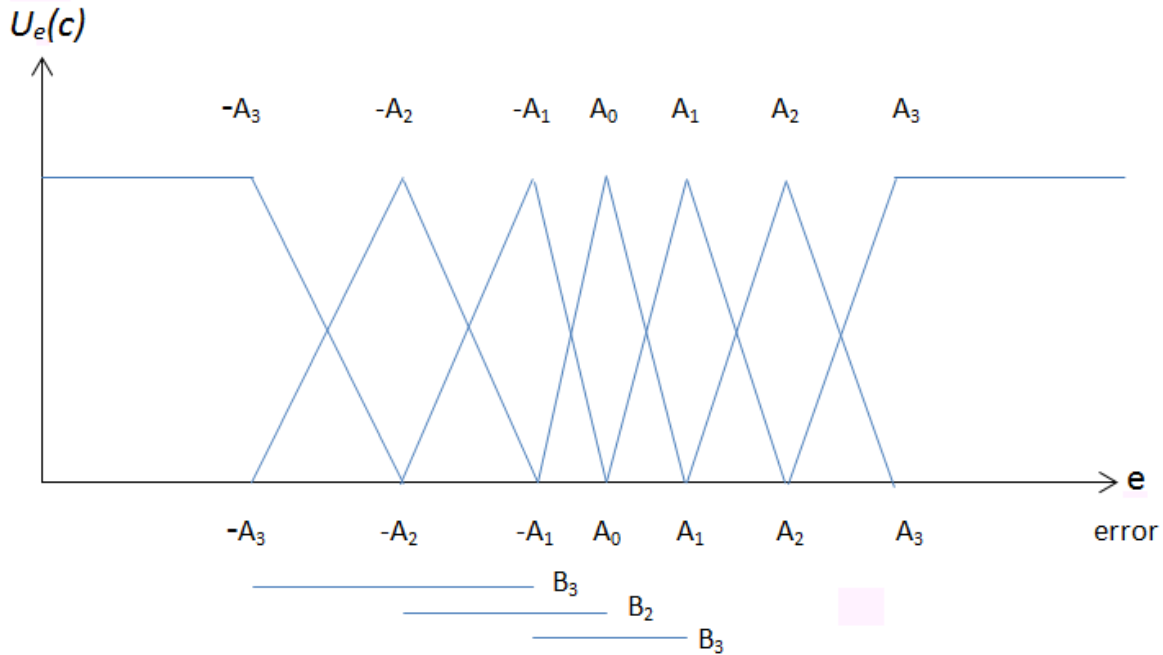

Fig.6. The family of the membership functions.

If shrinking factors is chosen one ( $s = 1$ ), the membership functions have equal span. By applying various shrinking factors to the same linguistic variable, deferent membership function obtained to examine which is the most suitable for a specific application process. Let us take that  $b$  is the overlapping factor whose reasonable range is  $[0, 1]$ . In our case we will consider that  $b$  can take values greater than unity as long as we as experts consider that resultant membership functions are rational in applications. The overlapping region increases monotonously as  $b$  increases. For  $b = 0$  it is clear that there is no overlap between the SSMFs. Diversity of  $b$  is shown in Fig.6 as  $B_1$ ,  $B_2$ , and  $B_3$ . Consider  $B=1$  the supports for the SSMFs have proper overlapping region.

For a Mamdani-type FLC [21], fuzzy rules are in the form:

$R_i$  : **IF**  $e$  is  $A_i$  and  $de$  is  $B_i$  **THEN**  $du_k$  is  $C_i$ , where  $A_i$  and  $B_i$  are fuzzy subsets in their universe of discourse and  $C_i$  is a fuzzy singleton.

Each universe of discourse is divided into seven (as an example; for more information see [ 22] fuzzy subsets: **PB** (Positive Big), **PM** (Positive Medium), **PS** (Positive Small), **ZE** (Zero), **NS** (Negative Small), **NM** (Negative Medium) and **NB** (Negative Big).

The rule base of the FLC is created the way to make it easy to obtain membership functions with index representation method.

Table 1 illustrates the index representation of a simple rule mapping for  $m_1 = m_2 = 3$  and the FLC has two inputs, single output

By naming the numbered symbols (0 ? Zero, 1 ? Positive Small, 2 ? Positive Medium. . . , 1 ? Negative Small, 2? Negative Medium. . .), one can recognize anti-diagonal rule base proposed by

number of authors [18,20,21]. Table 2 illustrates the linguistic labels representation of the control rule table.

The inference result of each rule consists of two parts of weighting factor,  $w_i$ , of the individual rule, and degree of change in duty ratio  $C_i$ , according to the rule. The weighting factor  $w_i$  is obtained by means of Mamdani's *MIN* fuzzy implication of membership degrees  $\mu_e(e)$  and  $\mu_{de}(de)$ .  $C_i$  is retrieved from control rule table. As a result the inferred output of each rule using Mamdani's *MIN* fuzzy implication is given as

$$w_i = \min \{ \mu_e(e), \mu_{de}(de) \} \quad (9)$$

$$z_i = w_i \cdot C_i \quad (10)$$

where  $z_i$  denotes the fuzzy representation of change in duty ratio inferred by the  $i$ -th rule.

Table 1  
Simple rule mapping with index representation

elde	-3	-2	-1	0	1	2	3
3	0	1	2	3	4	5	6
2	-1	0	1	2	3	4	5
1	-2	-1	0	1	2	3	4
0	-3	-2	-1	0	1	2	3
-1	-4	-3	-2	-1	0	1	2
-2	-5	-4	-3	-2	-1	0	1
-3	-6	-5	-4	-3	-2	-1	0

Table 2  
The linguistic labels representation of rule base

elde	NB	NM	NS	ZE	PS	PM	PB
PB	ZE	PS	PM	PB	PB	PB	PB
PM	NS	ZE	PS	PM	PB	PB	PB
PS	NM	NS	ZE	PS	PM	PB	PB
ZE	NB	NM	NS	ZE	PS	PM	PB
NS	NB	NB	NM	NS	ZE	PS	PM
NM	NB	NB	NB	NM	NS	ZE	PS
NB	NB	NB	NB	NB	NM	NS	ZE

The results above results were received as linguistic results therefore we must employ next a defuzzification operator to obtain a crisp result. Among others we prefer center of gravity method for defuzzification  $Z$  is equal to  $du$  where  $Z$  or  $du$  is the result of change in duty ratio  $du$ .



### 3. Modernized algorithm for the fuzzy logic controller

MFLC, which is discussed in this paper, is an ordinary FLC with a modernized (adaptation) algorithm. Thus, MFLC adapts membership functions and computes the consequent parts of rules in the rule base. The inputs of MFLC are model data in the pattern file that is created from some expert knowledge data for desired output. The outputs of the controller are membership functions and the consequent parts for the controller. The MFLC updates its parameters (which are membership function's shrinking factors)  $S_e$ ,  $S_{de}$  and  $S_u$  according to the pattern file, by using modified algorithm.

Finally, application of this adaptation algorithm can be accepted as adaptation of parameters as well as the training data in the pattern file.

The implementation of the MFLC is made for boost, buck, and buck–boost converters as part of the MPPT system. The circuit components and parameters of these converters can be found in [21,22]. It has two inputs and one output. Number of Antecedent membership functions for inputs and output can be in range of 5 or 7, as it is shown in [22]. Thus the rule base has 49 outputs. The output of rules **du** is the change of duty ratio.

At the first, the pattern file is to be prepared. It contain of three vectors which are error  $e$ , difference error **de** and change of duty ratio **du**. Each variable vector contains a number of sample data or by another words the number of training data in the pattern file.

The MFLC algorithm described above can be implemented on a number of devices. We will consider implementation on a ST52E420 microcontroller, which is an 8-bit microcontroller and the erasable EPROM version, which has 4 Kbytes program and data EPROM. This model has been chosen to perform, in an efficient way, both Boolean and fuzzy algorithms, in order to reach the best performances that the two methodologies allow. The schematic diagram of the controller circuit is illustrated in Fig. 7.

This microcontroller has another important role in allowing describing a problem using a linguistic model instead of mathematical model. The microcontroller includes an 8-bit sampling (A/D) converter with an 8 analog channel fast multiplexer and 2.5 reconfigurable digital ports in order to transfer data from/to the on-chip Register Files. A three independent PWM/Timers are included allows managing directly power devices and high frequency PWM controls.

The ST52T410/ST52x420 Decision Processor (DP) main features are: Up to 8 Inputs with 8-bit resolution; 1 Kbyte of Program/Data Memory available to store more than 300 to Membership Functions (Mbfs) for each Input; Up to 128 Outputs with 8-bit resolution; Possibility of processing fuzzy rules with an unlimited number of antecedents; unlimited number of Rules and Fuzzy Blocks.

The limits on the number of Fuzzy Rules and Fuzzy program blocks are only related to the Program/Data Memory size.

Fuzzy Inference: The ST52T410/ST52x420 Core allows for the implementation of a Mamdani type fuzzy inference with crisp consequents. Inputs for fuzzy inference are stored in 8 dedicated Fuzzy input registers. The LDFR instruction is used to set the Input Fuzzy registers with values

stored in the Register File. The result of a Fuzzy inference is stored directly in a location of the Register File.

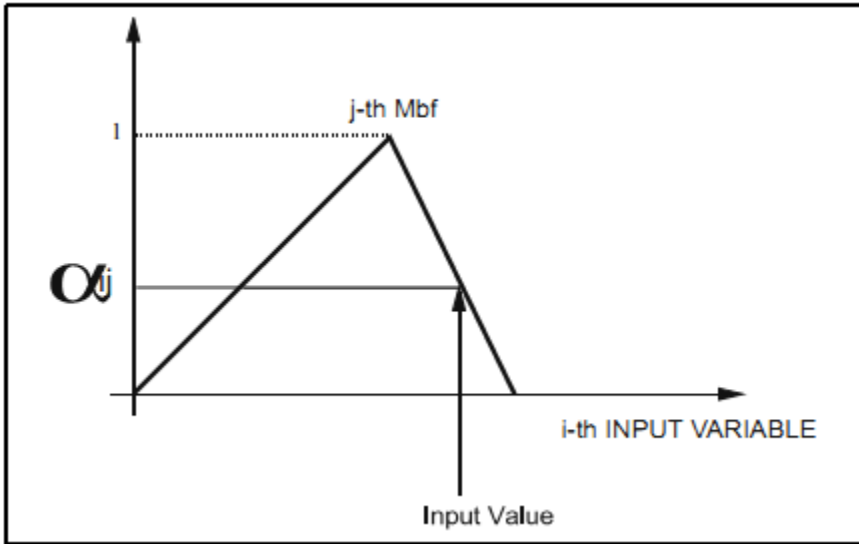

Fig.7. Microprocessor ST52T410/ST52x420 Alpha Weight Calculation.

AFLC is a FLC with an adaptation algorithm. Thus, MFLC adapts membership functions and computes the consequent parts of rules in the rule base. The inputs of MFLC are model data in the pattern file that is created from some data for desired output. The outputs of MFLC are membership functions and the consequent parts for FLC.

The MFLC can update its parameters which are membership function's shrinking factors  $s_e$ ,  $s_d$  and  $s_u$ , according with the MFLC. The simulation and the implementation of the MFLC for buck, boost and buck–boost converters results demonstrated that the converters are stable and can be regulated with a good performance under different input disturbance and load variation. The results also indicate that the MFLC is general and can be applied to any DC–DC converter topologies. Thus, the same microcontroller software can be used to control any switch-mode converters without any modifications.

### Conclusion

In this paper, a modernized fuzzy logic controller was introduced for DC–DC converter output voltage regulation in MPPT system in PhV station and have implemented on an 8-bit microcontroller. The MFLC is able to regulate the output voltage of buck, boost and buck–boost converters to desired value despite change in load. Since these converters, buck, boost and buck–boost, are controlled using the same MFLC algorithm without any modifications to microcontroller program. This shows that the proposed algorithm is general and can be applied to any DC–DC converter topologies practically.

## References

1. E. Koutroulis, F. Blaabjerg, "A New Technique for Tracking Global Maximum Power Point of PV Arrays Operating Under Partial-Shading Conditions" *IEEE JOURNAL OF PHOTOVOLTAICS*, vol. 2, no. 2, April 2012
2. Трещ, А.М. Система управления фотоэлектрической установкой при автономном использовании / Ю.Н. Петренко, А.М. Трещ // Наука и техника. Международной научно-технической журнал. Минск 2013 №1. С .53-56
3. M. Azab, "A New Maximum Power Point Tracking for Photovoltaic Systems," in *WASET.ORG*, vol. 34, 2008, pp. 571-574.
4. D. P. Hohm and M. E. Ropp, "Comparative Study of Maximum Power Point Tracking Algorithms", *Prog. Photovolt: Res. Appl.* 2003; 11:47–62 (DOI:1002/pp.459)
5. T. Esram, P.L. Chapman, "Comparison of Photovoltaic Array Maximum Power Point Tracking Techniques," *IEEE Transactions on Energy Conversion*, vol. 22, no. 2, pp. 439-449, June 2007.
6. Messaouda AZZOUZI, "Comparaison between MPPT P&O and MPPT Fuzzy Controls in Optimizing the Photovoltaic Generator", *International Journal of Advanced Computer Science and Applications*, Vol. 3, No. 12, 2012
7. Hairul Nissah Zainudin, "Comparison Study of Maximum Power Point Tracker Techniques for PV Systems", 14th International Middle East Power Systems Conference (MEPCON'10), Cairo University, Egypt, December 19-21, 2010
8. D. P. Hohm and M. E. Ropp, "Comparative Study of Maximum Power Point Tracking Algorithms", *Prog. Photovolt: Res. Appl.* 2003; 11:47–62 (DOI:1002/pp.459)
9. Alejo, D., Maussion, P., & Faucher, J. (2003). Multiple model control of a buck DC/DC converter. *Mathematics and Computers in Simulation*, 63, pp.249–260.
10. Gupta, T., Boudreaux, R. R., Nelms, R. M., & Hung, J. Y. (1997). Implementation of a fuzzy logic controller for DC–DC converters using an inexpensive 8-b microcontroller. *IEEE Transaction on Industrial Electronics*, 44(5), pp. 661–668.
11. Higuchi, K., Nakano, K., Kajikawa, T., Takegami, E., Tomioka, S., & Watanabe, K. (2004). Robust control of DC–DC converter by high-order approximate 2-degree-of-freedom digital controller, *IECON*, pp.1839–1844).
12. Caldero ´n, A. J., Vinagre, B. M., & Feliu, V. (2006). Fractional order control strategies for power electronic buck converters. *Signal Processing*, 86(10), pp. 2803–2819.
13. Mac Vicar Whelan, P. J. (1977). Fuzzy set for man machine interaction". *International Journal of Man–Machine Studies*, 8, pp. 687–697.
14. Bor-Ren Lin, "Analysis of Fuzzy Control Method Applied to DC-DC Converter Control", *IEEE Prowe. APK'93*, pp.22-28,1993.
15. Rubai, A., Ofoli, A. R., Burge, L., & Garuba, M. (2005). Hardware Implementation of an adaptive network-based fuzzy controller for DC–DC converters. *IEEE Transactions on Industry Applications*, 41(6), pp. 1557–1565.
16. Elmas, C., Deperlioglu, O., Sayan, H.H. Adaptive fuzzy logic controller for DC-DC converters. *Expert Systems with Applications*, 36 (2009), pp. 1540-1548
17. Carroasco, C.M., Torralba, A., Ridao, F. P., & Franquelo, L. G. (1994). A fuzzy logic controller for power converters using a cell state algorithm. In *IEEE international*

conference on industrial electronics, control and instrumentation, IECON'94 (pp. 1325–1330), Bologna.

18. Chien, C. L., & Hsieh, C. T. (1996). User-friendly design method for fuzzy logic controller. *IEE Pro-Control Theory Application*, 143(4), 358–366.
19. Galichet, S., & Foulloy, L. (1995). IEEE fuzzy logic controllers: synthesis and equivalencies. *Transactions on Fuzzy Systems*, 3(2), pp. 140–148.
20. Huh, S., & Park, G. (1999). An adaptive fuzzy logic controller for power converters. In *FUZZY-IEEE '99*. (Vol. 1, pp. 434–439).
21. Mattavelli, P., Rossetta, L., Spiazzi, G., & Tenti, P. General-purpose fuzzy logic controller for DC–DC converters. *IEEE Transactions on Power Electronics*, 12(1), 1997, pp.79–85.
22. Petrenko, Y.N. Fuzzy logic and genetic algorithm technique for non-linear system of overhead crane / Y.N. Petrenko, S.E. Alavi *Computational Technologies in Electrical and Electronics Engineering (SIBIRCON), 2010 IEEE Region 8 International Conference* , 11-15 July 2010. pp. 848 - 851.
23. Алави, С.Э. Fuzzy logic controller for non-linear system design / С.Э. Алави, Ю.Н. Петренко // *Информационные технологии в промышленности: сборник тезисов пятой Международной научно-технической конференции ИТИ\*2008*, г. Минск, 22-24 октябрь 2008.– С. 214-215.
24. Alavi, S.E. System control, based on the artificial intelligence techniques / S.E. Alavi, Y.N. Petrenko // *Информационные технологии в промышленности: сборник тезисов шестой Международной научно-технической конференции ИТИ\*2010*, г. Минск, 28-29 октябрь 2010.– С. 170-171.